

Reference Manual for the 54 Mbps Wireless Router WGR614 v6

NETGEAR

NETGEAR, Inc.
4500 Great America Parkway
Santa Clara, CA 95054 USA

202-10036-01
Version 1.5
July 2004

© 2004 by NETGEAR, Inc. All rights reserved. July 2004.

Trademarks

NETGEAR is a trademark of Netgear, Inc.

Microsoft, Windows, and Windows NT are registered trademarks of Microsoft Corporation.

Other brand and product names are registered trademarks or trademarks of their respective holders.

Statement of Conditions

In the interest of improving internal design, operational function, and/or reliability, NETGEAR reserves the right to make changes to the products described in this document without notice.

NETGEAR does not assume any liability that may occur due to the use or application of the product(s) or circuit layout(s) described herein.

Industry Canada Statement

Operation is subject to the following two conditions:

- 1) this device may not cause interference and
- 2) this device must accept any interference, including interference that may cause undesired operation of the device

This device has been designed to operate with an antenna having a maximum gain of 2.dBi.

Antenna having a higher gain is strictly prohibited per regulations of Industry Canada. The required antenna impedance is 50 ohms.

To reduce potential radio interference to other users, the antenna type and its gain should be so chosen that the EIRP is not more than required for successful communication.

To prevent radio interference to the licensed service, this device is intended to be operated indoors and away from windows to provide maximum shielding.

Equipment (or its transmit antenna) that is installed outdoors is subject to licensing.

EN 55 022 Declaration of Conformance

This is to certify that the 54 Mbps Wireless Router WGR614 v6 is shielded against the generation of radio interference in accordance with the application of Council Directive 89/336/EEC, Article 4a. Conformity is declared by the application of EN 55 022 Class B (CISPR 22).

Bestätigung des Herstellers/Importeurs

Es wird hiermit bestätigt, daß das 54 Mbps Wireless Router WGR614 v6 gemäß der im BMPT-AmtsblVfg 243/1991 und Vfg 46/1992 aufgeführten Bestimmungen entstört ist. Das vorschriftsmäßige Betreiben einiger Geräte (z.B. Testsender) kann jedoch gewissen Beschränkungen unterliegen. Lesen Sie dazu bitte die Anmerkungen in der Betriebsanleitung.

Das Bundesamt für Zulassungen in der Telekommunikation wurde davon unterrichtet, daß dieses Gerät auf den Markt gebracht wurde und es ist berechtigt, die Serie auf die Erfüllung der Vorschriften hin zu überprüfen.

Certificate of the Manufacturer/Importer

It is hereby certified that the 54 Mbps Wireless Router WGR614 v6 has been suppressed in accordance with the conditions set out in the BMPT-AmtsblVfg 243/1991 and Vfg 46/1992. The operation of some equipment (for example, test transmitters) in accordance with the regulations may, however, be subject to certain restrictions. Please refer to the notes in the operating instructions.

Federal Office for Telecommunications Approvals has been notified of the placing of this equipment on the market and has been granted the right to test the series for compliance with the regulations.

Voluntary Control Council for Interference (VCCI) Statement

This equipment is in the second category (information equipment to be used in a residential area or an adjacent area thereto) and conforms to the standards set by the Voluntary Control Council for Interference by Data Processing Equipment and Electronic Office Machines aimed at preventing radio interference in such residential areas.

When used near a radio or TV receiver, it may become the cause of radio interference.

Read instructions for correct handling.

Customer Support

Refer to the Support Information Card that shipped with your 54 Mbps Wireless Router WGR614 v6.

World Wide Web

NETGEAR maintains a World Wide Web home page that you can access at the universal resource locator (URL) <http://www.netgear.com>. A direct connection to the Internet and a Web browser such as Internet Explorer or Netscape are required.

Federal Communications Commission (FCC) Compliance Notice: Radio Frequency Notice

Federal Communication Commission Interference Statement

This equipment has been tested and found to comply with the limits for a Class B digital device, pursuant to Part 15 of the FCC Rules. These limits are designed to provide reasonable protection against harmful interference in a residential installation. This equipment generates, uses and can radiate radio frequency energy and, if not installed and used in accordance with the instructions, may cause harmful interference to radio communications. However, there is no guarantee that interference will not occur in a particular installation. If this equipment does cause harmful interference to radio or television reception, which can be determined by turning the equipment off and on, the user is encouraged to

try to correct the interference by one of the following measures:

- Reorient or relocate the receiving antenna.
- Increase the separation between the equipment and receiver.
- Connect the equipment into an outlet on a circuit different from that to which the receiver is connected.
- Consult the dealer or an experienced radio/TV technician for help.

This device complies with Part 15 of the FCC Rules. Operation is subject to the following two conditions: (1) This device may not cause harmful interference, and (2) this device must accept any interference received, including interference that may cause undesired operation.

FCC Caution: Any changes or modifications not expressly approved by the party responsible for compliance could void the user's authority to operate this equipment.

IMPORTANT NOTE:

FCC Radiation Exposure Statement:

This equipment complies with FCC radiation exposure limits set forth for an uncontrolled environment. This equipment should be installed and operated with minimum distance 20cm between the radiator & your body.

This transmitter must not be co-located or operating in conjunction with any other antenna or transmitter.

Netgear declared that WGR614v6 is limited in CH1~11 from 2412 to 2462 MHz by specified firmware controlled in USA.

Contents

Chapter 1

About This Manual

Audience, Scope, Conventions, and Formats	1-1
How to Use This Manual	1-2
How to Print this Manual	1-3

Chapter 2

Introduction

Key Features	2-1
802.11g Wireless Networking	2-2
A Powerful, True Firewall with Content Filtering	2-2
Security	2-3
Autosensing Ethernet Connections with Auto Uplink	2-3
Extensive Protocol Support	2-4
Easy Installation and Management	2-4
Maintenance and Support	2-5
Package Contents	2-5
The Router's Front Panel	2-6
The Router's Rear Panel	2-7
A Road Map for 'How to Get There From Here'	2-7

Chapter 3

Connecting the Router to the Internet

Prepare to Install Your Wireless Router	3-1
First, Connect the Wireless Router to the Internet	3-1
Now, Set Up a Computer for Wireless Connectivity	3-7
Troubleshooting Tips	3-8
Overview of How to Access the Wireless Router	3-9
How to Log On to the Wireless Router After Configuration Settings Have Been Applied	3-10
How to Bypass the Configuration Assistant	3-12

How to Manually Configure Your Internet Connection	3-13
Using the Smart Setup Wizard	3-15
NETGEAR Product Registration, Support, and Documentation	3-16
Chapter 4	
Wireless Configuration	
Observe Performance, Placement, and Range Guidelines	4-1
Implement Appropriate Wireless Security	4-2
Understanding Wireless Settings	4-3
Information to Gather Before Changing Basic Wireless Settings	4-6
Default Factory Settings	4-7
How to Set Up and Test Basic Wireless Connectivity	4-7
How to Configure WEP	4-9
How to Configure WPA-PSK Wireless Security	4-11
How to Restrict Wireless Access by MAC Address	4-11
Chapter 5	
Content Filtering	
Content Filtering Overview	5-1
Blocking Access to Internet Sites	5-2
Blocking Access to Internet Services	5-3
Configuring a User Defined Service	5-4
Configuring Services Blocking by IP Address Range	5-5
Scheduling When Blocking Will Be Enforced	5-5
Viewing Logs of Web Access or Attempted Web Access	5-6
Configuring E-Mail Alert and Web Access Log Notifications	5-7
Chapter 6	
Maintenance	
Viewing Wireless Router Status Information	6-1
Viewing a List of Attached Devices	6-5
Configuration File Management	6-5
Restoring and Backing Up the Configuration	6-6
Erasing the Configuration	6-7
Upgrading the Router Software	6-7
Changing the Administrator Password	6-8
Chapter 7	
Advanced Configuration of the Router	
Configuring Port Triggering	7-1

Configuring Port Forwarding to Local Servers	7-3
Adding a Custom Service	7-5
Editing or Deleting a Port Forwarding Entry	7-5
Local Web and FTP Server Example	7-6
Multiple Computers for Half Life, KALI or Quake III Example	7-6
Configuring the WAN Setup Options	7-7
Connect Automatically, as Required	7-7
Disabling the SPI Firewall	7-8
Setting Up a Default DMZ Server	7-8
Responding to Ping on Internet WAN Port	7-8
Setting the MTU Size	7-9
Using the LAN IP Setup Options	7-10
Configuring LAN TCP/IP Setup Parameters	7-10
Using the Router as a DHCP server	7-12
Using Address Reservation	7-12
Using a Dynamic DNS Service	7-13
Configuring Static Routes	7-14
Enabling Remote Management Access	7-16
Using Universal Plug and Play (UPnP)	7-17

Chapter 8

Troubleshooting

Basic Functioning	8-1
Power Light Not On	8-1
Lights Never Turn Off	8-2
LAN or WAN Port Lights Not On	8-2
Troubleshooting the Web Configuration Interface	8-3
Troubleshooting the ISP Connection	8-4
Troubleshooting a TCP/IP Network Using a Ping Utility	8-5
Testing the LAN Path to Your Router	8-5
Testing the Path from Your Computer to a Remote Device	8-6
Restoring the Default Configuration and Password	8-7
Problems with Date and Time	8-8

Appendix A
Technical Specifications

Appendix B
Network, Routing, Firewall, and Basics

Related Publications	B-1
Basic Router Concepts	B-1
What is a Router?	B-1
Routing Information Protocol	B-2
IP Addresses and the Internet	B-2
Netmask	B-4
Subnet Addressing	B-4
Private IP Addresses	B-7
Single IP Address Operation Using NAT	B-7
MAC Addresses and Address Resolution Protocol	B-8
Related Documents	B-9
Domain Name Server	B-9
IP Configuration by DHCP	B-10
Internet Security and Firewalls	B-10
What is a Firewall?	B-10
Stateful Packet Inspection	B-11
Denial of Service Attack	B-11
Ethernet Cabling	B-11
Category 5 Cable Quality	B-12
Inside Twisted Pair Cables	B-13
Uplink Switches, Crossover Cables, and MDI/MDIX Switching	B-14

Appendix C
Preparing Your Network

What You Need To Use a Router with a Broadband Modem	C-1
Cabling and Computer Hardware	C-1
Computer Network Configuration Requirements	C-1
Internet Configuration Requirements	C-2
Where Do I Get the Internet Configuration Parameters?	C-2
Record Your Internet Connection Information	C-3
Preparing Your Computers for TCP/IP Networking	C-3
Configuring Windows 95, 98, and Me for TCP/IP Networking	C-4

Install or Verify Windows Networking Components	C-4
Enabling DHCP to Automatically Configure TCP/IP Settings in Windows 95B, 98, and Me C-6	
Selecting Windows' Internet Access Method	C-8
Verifying TCP/IP Properties	C-8
Configuring Windows NT4, 2000 or XP for IP Networking	C-9
Install or Verify Windows Networking Components	C-9
DHCP Configuration of TCP/IP in Windows XP, 2000, or NT4	C-10
DHCP Configuration of TCP/IP in Windows XP	C-10
DHCP Configuration of TCP/IP in Windows 2000	C-12
DHCP Configuration of TCP/IP in Windows NT4	C-15
Verifying TCP/IP Properties for Windows XP, 2000, and NT4	C-17
Configuring the Macintosh for TCP/IP Networking	C-18
MacOS 8.6 or 9.x	C-18
MacOS X	C-18
Verifying TCP/IP Properties for Macintosh Computers	C-19
Verifying the Readiness of Your Internet Account	C-20
Are Login Protocols Used?	C-20
What Is Your Configuration Information?	C-20
Obtaining ISP Configuration Information for Windows Computers	C-21
Obtaining ISP Configuration Information for Macintosh Computers	C-22
Restarting the Network	C-23

Appendix D

Wireless Networking Basics

Wireless Networking Overview	D-1
Infrastructure Mode	D-1
Ad Hoc Mode (Peer-to-Peer Workgroup)	D-2
Network Name: Extended Service Set Identification (ESSID)	D-2
Wireless Channels	D-2
WEP Wireless Security	D-4
WEP Authentication	D-4
WEP Open System Authentication	D-5
WEP Shared Key Authentication	D-6
Key Size and Configuration	D-7
How to Use WEP Parameters	D-8
WPA Wireless Security	D-8

How Does WPA Compare to WEP?	D-9
How Does WPA Compare to IEEE 802.11i?	D-10
What are the Key Features of WPA Security?	D-10
WPA Authentication: Enterprise-level User Authentication via 802.1x/EAP and RADIUS	D-12
WPA Data Encryption Key Management	D-14
Is WPA Perfect?	D-16
Product Support for WPA	D-16
Supporting a Mixture of WPA and WEP Wireless Clients	D-16
Changes to Wireless Access Points	D-16
Changes to Wireless Network Adapters	D-17
Changes to Wireless Client Programs	D-18

Glossary

List of Glossary Terms	G-1
------------------------------	-----

Index

Chapter 1

About This Manual

This chapter describes the intended audience, scope, conventions, and formats of this manual.

Audience, Scope, Conventions, and Formats

This reference manual assumes that the reader has basic to intermediate computer and Internet skills. However, basic computer network, Internet, firewall, and VPN technologies tutorial information is provided in the Appendices and on the Netgear Web site.

This guide uses the following typographical conventions:

Table 1-1. Typographical Conventions

<i>italics</i>	Emphasis, books, CDs, URL names
bold	User input
SMALL CAPS	Screen text, file and server names, extensions, commands, IP addresses

This guide uses the following format to highlight special messages:

	Note: This format is used to highlight information of importance or special interest.
-------------------------------------------------------------------------------------	----------------------------------------------------------------------------------------------

This manual is written for the WGR614 v6 router according to these specifications.

Table 1-2. Manual Scope

Product Version	54 Mbps Wireless Router WGR614 v6
Manual Publication Date	July 2004

	Note: Product updates are available on the NETGEAR Web site at http://kbserver.netgear.com/products/WGR614v6.asp .
-------------------------------------------------------------------------------------	-------------------------------------------------------------------------------------------------------------------------------------------------------------------------------------------

How to Use This Manual

The HTML version of this manual includes a variety of navigation features as well as links to PDF versions of the full manual and individual chapters.

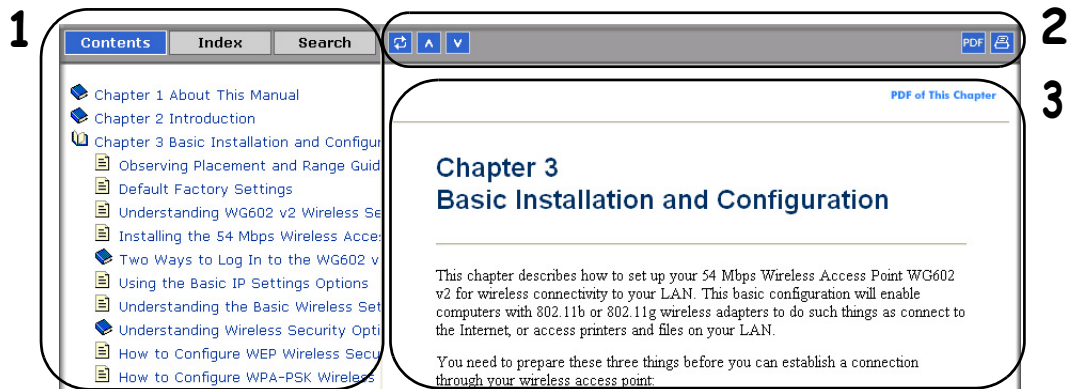

Figure 1 -1: HTML version of this manual

1. **Left pane.** Use the left pane to view the Contents, Index, Search, and Favorites tabs.

To view the HTML version of the manual, you must have a version 4 or later browser with JavaScript enabled.

2. **Toolbar buttons.** Use the toolbar buttons across the top to navigate, print pages, and more.



The Show in Contents button locates the current topic in the Contents tab.



Previous/Next buttons display the previous or next topic.



The PDF button links to a PDF version of the full manual.



The Print button prints the current topic. Click this button when a step-by-step procedure is displayed to send the entire procedure to your printer. You do not have to worry about specifying the correct range of pages.

3. **Right pane.** Use the right pane to view the contents of the manual. Also, each page of the manual includes a [PDF of This Chapter](#) link at the top right which links to a PDF file containing just the currently selected chapter of the manual.

How to Print this Manual

To print this manual you can choose one of the following several options, according to your needs.

- **Printing a “How To” Sequence of Steps in the HTML View.**

Use the *Print* button  on the upper right of the toolbar to print the currently displayed topic. Use this button when a step-by-step procedure is displayed to send the entire procedure to your printer. You do not have to worry about specifying the correct range of pages.

- **Printing a Chapter.**

Use the **PDF of This Chapter** link at the top right of any page.

- Click “PDF of This Chapter” link at the top right of any page in the chapter you want to print. The PDF version of the chapter you were viewing opens in a browser window.

Note: Your computer must have the free Adobe Acrobat reader installed in order to view and print PDF files. The Acrobat reader is available on the Adobe Web site at <http://www.adobe.com>.

- Click the print icon in the upper left of the window.

Tip: If your printer supports printing two pages on a single sheet of paper, you can save paper and printer ink by selecting this feature.

- **Printing the Full Manual.**

Use the PDF button in the toolbar at the top right of the browser window.

- Click the PDF button  on the upper right of the toolbar. The PDF version of the chapter you were viewing opens in a browser window.
- Click the print icon in the upper left of the window.

Tip: If your printer supports printing two pages on a single sheet of paper, you can save paper and printer ink by selecting this feature.

Chapter 2

Introduction

Congratulations on your purchase of the NETGEAR® 54 Mbps Wireless Router WGR614 v6. The WGR614 v6 router provides connection for multiple computers to the Internet through an external broadband access device (such as a cable modem or DSL modem) that is normally intended for use by a single computer. This chapter describes the features of the NETGEAR 54 Mbps Wireless Router WGR614 v6.

Key Features



Note: This manual provides information on the complete features as of the date of publication. Earlier versions of this product may not have all the features presented in this manual. Go to <http://kbserver.netgear.com/products/WGR614v6.asp> where you will find product firmware updates for your WGR614 v6.

The 54 Mbps Wireless Router WGR614 v6 with 4-port switch connects your local area network (LAN) to the Internet through an external access device such as a cable modem or DSL modem.

The WGR614 v6 router provides you with multiple Web content filtering options, plus browsing activity reporting and instant alerts via e-mail. Parents and network administrators can establish restricted access policies based on time-of-day, Web site addresses and address keywords, and share high-speed cable/DSL Internet access for up to 253 computers. In addition to the Network Address Translation (NAT) feature, the built-in firewall protects you from hackers.

With minimum setup, you can install and use the router within minutes.

The WGR614 v6 router provides the following features:

- 802.11g wireless networking, with the ability to operate in 802.11g-only, or 802.11b+g modes.
- Easy, Web-based setup for installation and management.
- Content Filtering and Site Blocking Security.
- Built in 4-port 10/100 Mbps Switch.

- Ethernet connection to a wide area network (WAN) device, such as a cable modem or DSL modem.
- Extensive Protocol Support.
- Login capability.
- Front panel LEDs for easy monitoring of status and activity.
- Flash memory for firmware upgrades.

802.11g Wireless Networking

The WGR614 v6 router includes an 802.11g wireless access point, providing continuous, high-speed 54 Mbps access between your wireless and Ethernet devices. The access point provides:

- 802.11g wireless networking at up to 54 Mbps.
- 802.11g wireless networking, with the ability to operate in 802.11g-only, 802.11b-only, or 802.11g and b modes, providing backwards compatibility with 802.11b devices or dedicating the wireless network to the higher bandwidth 802.11g devices.
- 64-bit and 128-bit WEP encryption security.
- WEP keys can be generated manually or by passphrase.
- WPA-PSK support. Support for Wi-Fi Protected Access (WPA) data encryption which provides strong data encryption and authentication based on a pre-shared key.
- Wireless access can be restricted by MAC address.
- Wireless network name broadcast can be turned off so that only devices that have the network name (SSID) can connect.

A Powerful, True Firewall with Content Filtering

Unlike simple Internet sharing NAT routers, the WGR614 v6 is a true firewall, using stateful packet inspection to defend against hacker attacks. Its firewall features include:

- Denial of Service (DoS) protection.
Automatically detects and thwarts DoS attacks such as Ping of Death, SYN Flood, LAND Attack, and IP Spoofing.
- Blocks unwanted traffic from the Internet to your LAN.
- Blocks access from your LAN to Internet locations or services that you specify as off-limits.

- Logs security incidents.

The WGR614 v6 will log security events such as blocked incoming traffic, port scans, attacks, and administrator logins. You can configure the router to E-mail the log to you at specified intervals. You can also configure the router to send immediate alert messages to your E-mail address or E-mail pager whenever a significant event occurs.

- The WGR614 v6 prevents objectionable content from reaching your computers. The router allows you to control access to Internet content by screening for keywords within Web addresses. You can configure the router to log and report attempts to access objectionable Internet sites.

Security

The WGR614 v6 router is equipped with several features designed to maintain security, as described in this section.

- Computers Hidden by NAT
NAT opens a temporary path to the Internet for requests originating from the local network. Requests originating from outside the LAN are discarded, preventing users outside the LAN from finding and directly accessing the computers on the LAN.
- Port Forwarding with NAT
Although NAT prevents Internet locations from directly accessing the computers on the LAN, the router allows you to direct incoming traffic to specific computers based on the service port number of the incoming request, or to one designated “DMZ” host computer. You can specify forwarding of single ports or ranges of ports.

Autosensing Ethernet Connections with Auto Uplink

With its internal 4-port 10/100 switch, the WGR614 v6 can connect to either a 10 Mbps standard Ethernet network or a 100 Mbps Fast Ethernet network. Both the LAN and WAN interfaces are autosensing and capable of full-duplex or half-duplex operation.

The router incorporates Auto Uplink™ technology. Each Ethernet port will automatically sense whether the Ethernet cable plugged into the port should have a ‘normal’ connection such as to a computer or an ‘uplink’ connection such as to a switch or hub. That port will then configure itself to the correct configuration. This feature also eliminates the need to worry about crossover cables, as Auto Uplink will accommodate either type of cable to make the right connection.

Extensive Protocol Support

The WGR614 v6 router supports the Transmission Control Protocol/Internet Protocol (TCP/IP) and Routing Information Protocol (RIP). For further information about TCP/IP, refer to [Appendix B, “Network, Routing, Firewall, and Basics.”](#)

- **IP Address Sharing by NAT**
The WGR614 v6 router allows several networked computers to share an Internet account using only a single IP address, which may be statically or dynamically assigned by your Internet service provider (ISP). This technique, known as NAT, allows the use of an inexpensive single-user ISP account.
- **Automatic Configuration of Attached computers by DHCP**
The WGR614 v6 router dynamically assigns network configuration information, including IP, gateway, and domain name server (DNS) addresses, to attached computers on the LAN using the Dynamic Host Configuration Protocol (DHCP). This feature greatly simplifies configuration of computers on your local network.
- **DNS Proxy**
When DHCP is enabled and no DNS addresses are specified, the router provides its own address as a DNS server to the attached computers. The router obtains actual DNS addresses from the ISP during connection setup and forwards DNS requests from the LAN.
- **PPP over Ethernet (PPPoE)**
PPPoE is a protocol for connecting remote hosts to the Internet over a DSL connection by simulating a dial-up connection. This feature eliminates the need to run a login program such as Entersys or WinPOET on your computer.

Easy Installation and Management

You can install, configure, and operate the 54 Mbps Wireless Router WGR614 v6 within minutes after connecting it to the network. The following features simplify installation and management tasks:

- **Browser-based management**
Browser-based configuration allows you to easily configure your router from almost any type of personal computer, such as Windows, Macintosh, or Linux. A user-friendly Setup Wizard is provided and online help documentation is built into the browser-based Web Management Interface.
- **Smart Wizard**
The WGR614 v6 router Smart Wizard automatically senses the type of Internet connection, asking you only for the information required for your type of ISP account.

- **Firmware Update**
The WGR614 v6 router can be updated if a newer version of firmware is available. This lets you take advantage of product enhancements for your WGR614 v6 as soon as they become available.
- **Visual monitoring**
The WGR614 v6 router's front panel LEDs provide an easy way to monitor its status and activity.

Maintenance and Support

NETGEAR offers the following features to help you maximize your use of the WGR614 v6 router:

- Flash memory for firmware upgrades.
- Free technical support seven days a week, twenty-four hours a day, for 90 days from the date of purchase.

Package Contents

The product package should contain the following items:

- 54 Mbps Wireless Router WGR614 v6.
- AC power adapter.
- Vertical stand.
- Category 5 (CAT5) Ethernet cable.
- *NETGEAR 54 Mbps Wireless Router WGR614 v6 Resource CD (230-10091-01)*, including:
 - This guide.
 - The Installation Guide.
 - Application Notes and other helpful information.
- *54 Mbps Wireless Router WGR614 v6 Installation Guide*.
- Registration, Warranty Card, and Support Information Card.

If any of the parts are incorrect, missing, or damaged, contact your NETGEAR dealer. Keep the carton, including the original packing materials, in case you need to return the router for repair.

The Router's Front Panel

The front panel of the WGR614 v6 router contains the status lights described below.

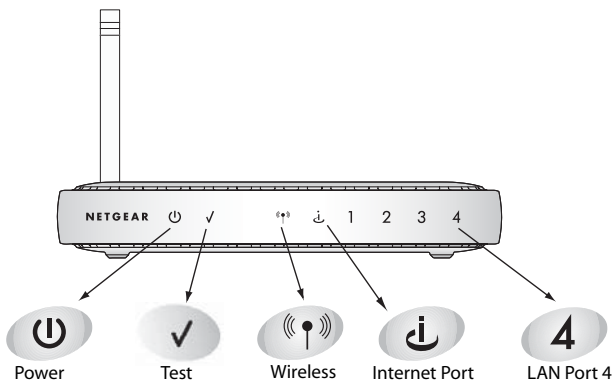

Figure 2-1: WGR614 v6 Front Panel

You can use the status lights to verify connections. Viewed from left to right, the table below describes the lights on the front panel of the router.

Table 2-1. Status Light Descriptions

Label	Activity	Description
Power	On Amber Blinking On Green Solid Off Solid Amber	Power is supplied to the router and it is performing its diagnostic test. Power is supplied and the router it has passed its diagnostic test. Power is not supplied to the router. The router has failed its diagnostic test.
Test	On Off	The unit is performing the power on self test diagnostic. The unit successfully completed the power on self test diagnostic.
Wireless	On Off	The Wireless port is initialized and the wireless feature is enabled. The wireless feature is turned off or there is a problem.
Internet	On Blink	The Internet port has detected a link with an attached device. Data is being transmitted or received by the Internet port.
LAN	On (Green) Blink (Green) On (Amber) Blink (Amber) Off	The LAN (local area network) port has detected link with a 100 Mbps device. Data is being transmitted or received at 100 Mbps. The Local port has detected link with a 10 Mbps device. Data is being transmitted or received at 10 Mbps. No link is detected on this port.

The Router's Rear Panel

The rear panel of the WGR614 v6 router contains the items listed below.

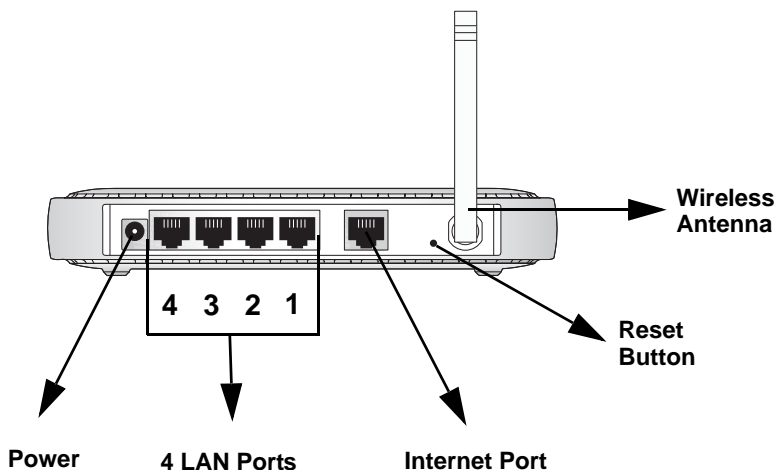

Figure 1-2: WGR614 v6 Rear Panel

Viewed from left to right, the rear panel contains the following features:

- AC power adapter outlet for **12 V DC @ 1A output, 22W maximum**
- Four Local (LAN) 10/100 Mbps Ethernet ports for connecting the router to the local computers
- Internet (WAN) Ethernet port for connecting the router to a cable or DSL modem
- Factory Default Reset push button for [Restoring the Default Configuration and Password](#)
- Wireless antenna

A Road Map for 'How to Get There From Here'

The introduction and adoption of any new technology can be a difficult process. Broadband Internet service is considered so useful that more and more people want to set up networks in their home to share a broadband connection. Wireless technology has removed one of the barriers to networking—running wires. It allows more people to try networking while at the same time

exposes them to the inherent complexity of networking. General networking concepts, setup, and maintenance can be difficult to understand. In addition, wireless technology adds issues, such as range, interference, signal quality, and security to the picture.

To help overcome potential barriers to successfully using home networks, the table below identifies how to accomplish such things as connecting to a wireless network, assuring appropriate security measures are taken, browsing the Internet through your wireless connection, exchanging files with other computers and using printers in the combined wireless and wired network.

Table 2-1. A Road Map for How to Get There From Here

If I Want To?	What Do I Do?	What's Needed?	How Do I?
Set up a wireless network	<ol style="list-style-type: none"> Set up the 54 Mbps Wireless Router WGR614 v6 Identify the wireless network name (SSID) and, if used, the wireless security settings. Set up the wireless computers with the settings from step 1. 	<ul style="list-style-type: none"> A wireless network A computer within the operating range of the wireless network. For guidelines about the range of wireless networks, see "Observe Performance, Placement, and Range Guidelines" on page 4-1. 	<p>To set up the WGR614 v6, see Chapter 3, "Connecting the Router to the Internet" and follow the instructions provided.</p> <p>To learn about wireless networking technology, see Appendix 4, "Wireless Configuration" for a general introduction.</p>
Protect my wireless connection from snooping, hacking, or information theft.	<ol style="list-style-type: none"> Assure that the wireless network has security features enabled. Configure my WGR614 v6 with the security settings of the wireless network. Use Windows security features. 	<ul style="list-style-type: none"> A wireless network WEP or WPA security enabled. Wireless networking equipment that supports WEP or WPA, such as the WGR614 v6. 	<p>To learn about wireless networking security, see "Wireless Networking Basics" on page D-1.</p> <p>To use WEP security features, see "Implement Appropriate Wireless Security" on page 4-2 and configure your WGR614 v6 accordingly.</p>
<p>Note: Secure Internet sites such as banks and online merchants use encryption security built into browsers like Internet Explorer and Netscape. Any wireless networking security features you might implement are in addition to those already in place on secure Internet sites.</p>			

Table 2-1. A Road Map for How to Get There From Here

If I Want To?	What Do I Do?	What's Needed?	How Do I?
<p>Share Windows PC files and printers at home in a combined wireless and wired network.</p> <p>Note: For sharing files and printers on other types of computers like Macintosh or Linux, refer to the product documentation that came with those computers.</p>	<ol style="list-style-type: none"> 1. Use the Windows Printers and Fax features to locate available printers in the combined wireless and wired network in your home. 2. Use the Windows Add a Printer wizard to add access to a network printer from the PC you are using to wirelessly connect to the network. 3. From the File menu of an application such as Microsoft Word, use the Print Setup feature to direct your print output to the printer in the network. 	<ul style="list-style-type: none"> • Windows computers (wired and wireless) I am using to connect to the network need to be configured with the Windows Client and File and Print Sharing. • Windows computers (wired and wireless) I am using to connect to the network need to be configured with the same Windows Workgroup or Domain settings as the other Windows computers in the combined wireless and wired network. • Any Windows networking security access rights such as login user name/ password that have been assigned in the Windows network must be provided when Windows prompts for such information. • If so-called Windows 'peer' networking is being used, the printer needs to be enabled for sharing. 	<p>Windows Domain settings are usually managed by corporate computer support groups.</p> <p>Windows Workgroup settings are commonly managed by individuals who want to set up small networks in their homes, or small offices.</p> <p>For assistance with setting up Windows networking, refer to the PC Networking Tutorial on the <i>NETGEAR 54 Mbps Wireless Router WGR614 v6 Resource CD (230-10091-01)</i> and the Help information provided in the Windows system you are using.</p> <p>For assistance with setting up printers in Windows, refer to the Help and Support information that comes with the version of the Windows operating systems you are using.</p>

Chapter 3

Connecting the Router to the Internet

This chapter describes how to set up the router on your local area network (LAN) and connect to the Internet. You will find out how to configure your 54 Mbps Wireless Router WGR614 v6 for Internet access using the Setup Wizard, or how to manually configure your Internet connection.

Follow these instructions to set up your router.

Prepare to Install Your Wireless Router

- Observe the wireless placement and range guidelines in “*Observe Performance, Placement, and Range Guidelines*” on page 4-1.
- *For Cable Modem Service:* When you perform the wireless router setup steps be sure to use the computer you first registered with your cable ISP.
- *For DSL Service:* You may need information such as the DSL login name/e-mail address and password in order to complete the wireless router setup.

Before proceeding with the wireless router installation, familiarize yourself with the contents of the *NETGEAR 54 Mbps Wireless Router WGR614 v6 Resource CD (230-10091-01)*, especially this manual and the animated tutorials for configuring networking on PCs.

First, Connect the Wireless Router to the Internet

1. CONNECT THE WIRELESS ROUTER, THE COMPUTER, AND THE MODEM
 - a. Turn off your computer.
 - b. Turn off the cable or DSL broadband modem.

- c. Locate the Ethernet cable (cable 1 in the diagram) that connects your PC to the modem.

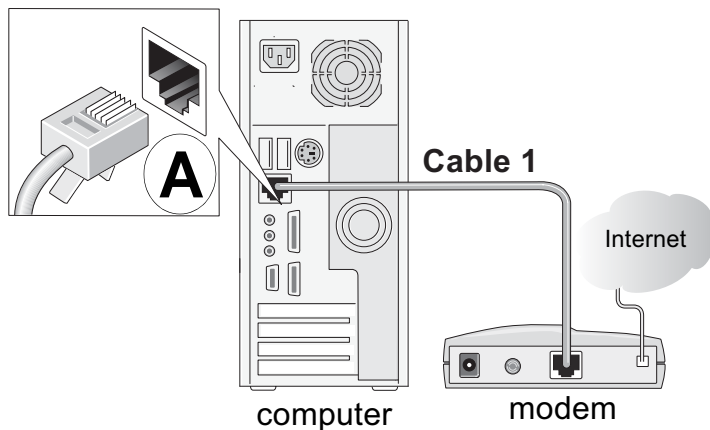

Figure 3-1: Disconnect the Ethernet cable from the computer

- d. Disconnect the cable at the computer end only, point **A** in the diagram above.
- e. Look at the label on the bottom of the wireless router. Locate the Internet port. Securely insert the Ethernet cable from your modem (cable 1 in the diagram below) into the Internet port of the wireless router as shown in point **B** of the diagram below.

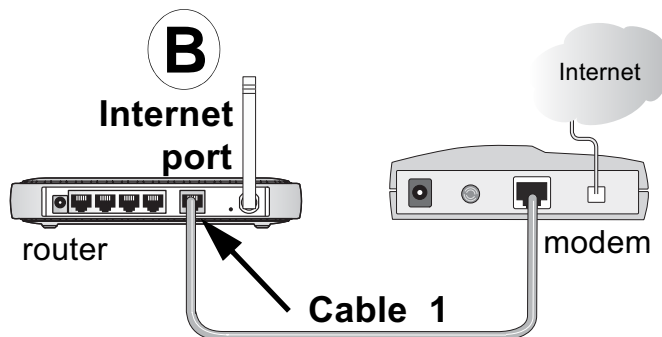

Figure 3-2: Connect the wireless router to the modem

Note: Place the WGR614 v6 router in a location which conforms to the “[Observe Performance, Placement, and Range Guidelines](#)” on page 4-1. The stand provided with the wireless router provides a convenient, space-saving way of installing the wireless router. Avoid stacking it on other electronic equipment.

- f. Securely insert the blue cable that came with your wireless router (the blue NETGEAR cable in the diagram below) into a LAN port on the router such as LAN port 4 (point C in the diagram), and the other end into the Ethernet port of your computer (point D in the diagram).

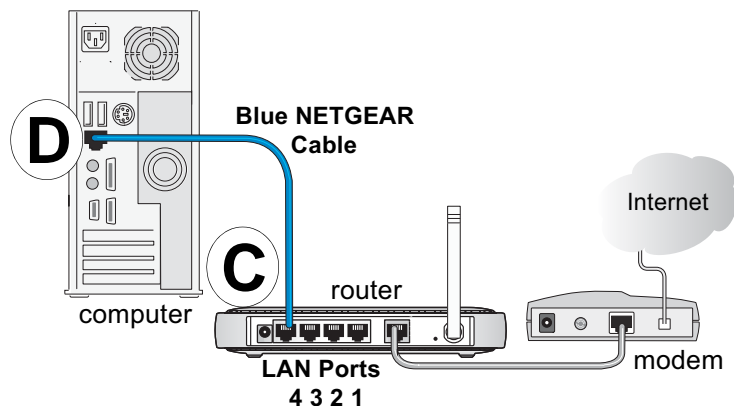

Figure 3-3: Connect the computer to the wireless router

Your network cables are connected and you are ready to restart your network.

2. RESTART YOUR NETWORK IN THE CORRECT SEQUENCE

Warning: Failure to restart your network in the correct sequence could prevent you from connecting to the Internet.

- a. First, turn on the broadband modem and wait 2 minutes.
- b. Now, plug in the power cord to your wireless router and wait 1 minute.
- c. Last, turn on your computer.

Note: For DSL customers, if software logs you in to the Internet, *do not* run that software. You may need to go to the Internet Explorer Tools menu, Internet Options, Connections tab page where you can select “Never dial a connection.”

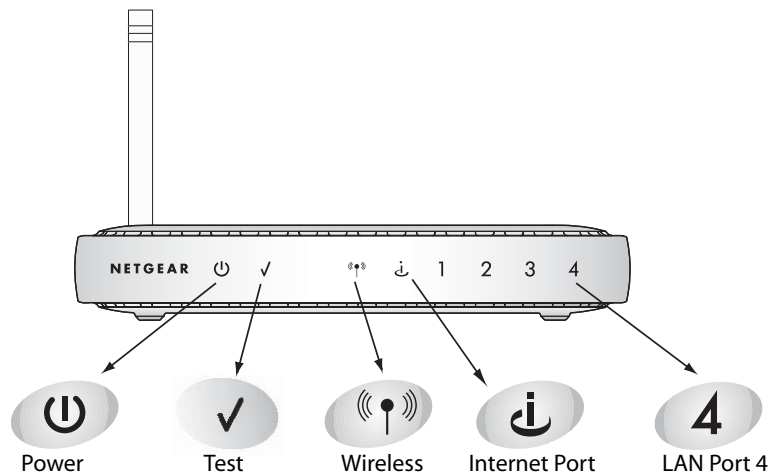

Figure 3-4: Verify the connections according to the status lights on the wireless router

- d. Check the wireless router status lights to verify the following:
 - *Power*: The power light should turn solid green. If it does not, see [“Troubleshooting Tips” on page 3-8](#).
 - *Test*: The test light blinks when the router is first turned on, then goes off. If after 2 minutes it is still on, see [“Troubleshooting Tips” on page 3-8](#).
 - *Internet*: The Internet port light should be lit. If not, make sure the Ethernet cable is securely attached to the wireless router Internet port and the modem, and the modem is powered on.
 - *Wireless*: The Wireless light should be lit. If the Wireless light is not lit, see [“Troubleshooting Tips” on page 3-8](#).
 - *LAN*: A LAN light should be lit. Green indicates your computer is communicating at 100 Mbps; yellow indicates 10 Mbps. If a LAN light is not lit, check that the Ethernet cable from the computer to the router is securely attached at both ends, and that the computer is turned on.

3. USE THE SMART WIZARD TO CONFIGURE THE WIRELESS ROUTER

- a. From the Ethernet connected PC you just set up, open a browser such as Internet Explorer or Netscape® Navigator.

In its factory default state, the wireless router will automatically display the NETGEAR Smart Wizard configuration assistant welcome page.

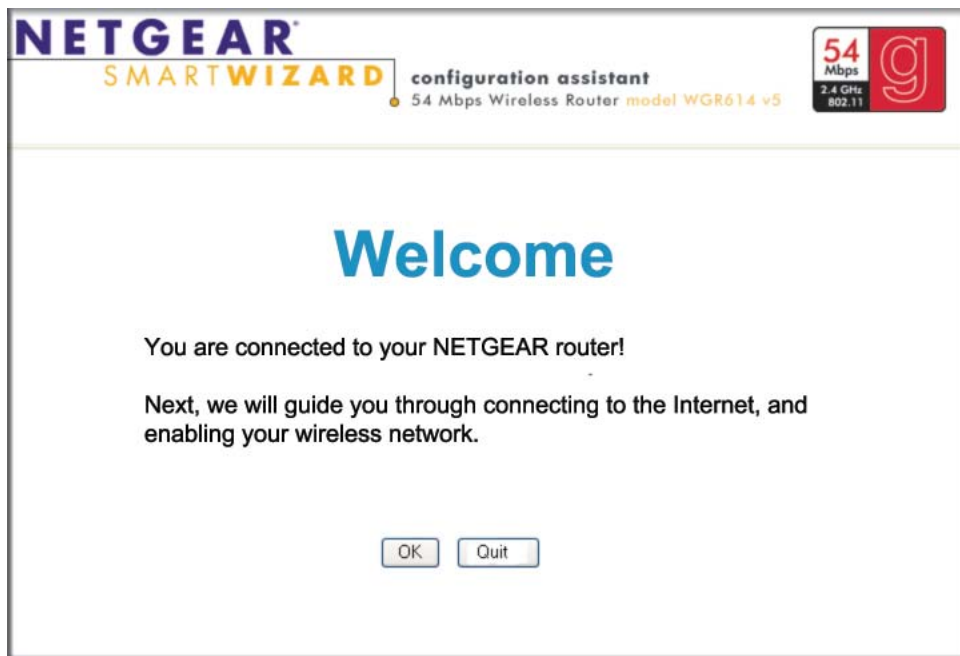

Figure 3-5: NETGEAR Smart Wizard configuration assistant

Note: If you do not see this page, clear the browser cache by going to the Internet Explorer Tools menu, Internet Options, and clicking Delete Files, then selecting the Delete all offline files check box and clicking OK.

If you still do not connect, type <http://www.routerlogin.net> in the browser address bar and click Enter. Otherwise, to bypass this screen, see “[How to Bypass the Configuration Assistant](#)” on page 3-12 and the “[How to Manually Configure Your Internet Connection](#)” on page 3-13 topics in this chapter.

If you cannot connect to the wireless router, verify your computer networking setup. It should be set to obtain *both* IP and DNS server addresses automatically, which is usually so. For help with this, see [Appendix C, “Preparing Your Network”](#) or the animated tutorials on the CD.

- b. Click **OK**. Follow the prompts to proceed with the Smart Wizard configuration assistant to connect to the Internet.

- c. Follow the instructions on the screen to enable the wireless feature.

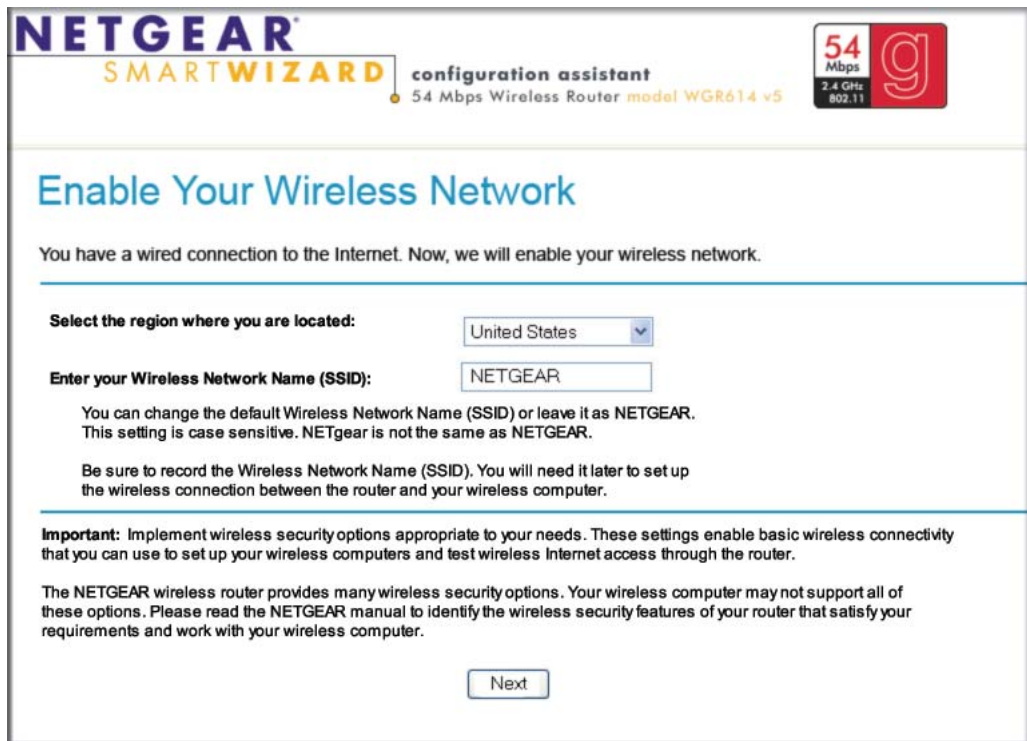

Figure 3-6: Enable the wireless feature

- d. Enable your wireless network, click **Next** to proceed, then click **Done** to finish. If you have trouble connecting to the Internet, see “[Troubleshooting Tips](#)” on page 3-8 to correct basic problems.

Note: The Smart Wizard configuration assistant only appears when the router is in its factory default state. After you configure the wireless router, it will not appear again. You can always connect to the router to change its settings. To do so, open a browser such as Internet Explorer and go to <http://www.routerlogin.net>. Then, when prompted, enter **admin** as the user name and **password** for the password, both in lower case letters.

You are now connected to the Internet and the wireless feature of the wireless router is enabled! Next, configure your wireless computer.

Now, Set Up a Computer for Wireless Connectivity

You are now connected to the Internet and the wireless feature of the wireless router is enabled! Next, configure your wireless computer.

1. CONFIGURE THE COMPUTER'S WIRELESS ADAPTER SETTINGS



Figure 3-7: Configure wireless computer

NETGEAR, Inc. wireless adapters display a list of available wireless networks, and, when wireless security is disabled, you simply choose yours from the list and connect.

For a non-NETGEAR wireless adapter, configure it to match your settings exactly. If you changed the default Network Name (SSID), be sure to use the correct Network Name (SSID) you set in the wireless router.

WIRELESS FEATURE	DEFAULT SETTING
Network Name (SSID)	NETGEAR
WEP Security	Disabled

Warning: The Network Name (SSID) is case sensitive. Typing nETgear will not work.

2. VERIFY WIRELESS CONNECTIVITY

Verify wireless connectivity. Connect to the Internet or log in to the wireless router from a computer with a wireless adapter. For wireless connectivity problems, see [“Troubleshooting Tips” on page 3-8](#).

You are now wirelessly connected to the Internet! Implement wireless security according to the instructions in [“Implement Appropriate Wireless Security” on page 4-2](#).

Troubleshooting Tips

Here are some tips for correcting simple problems you may have.

Be sure to restart your network in this sequence:

- 1) Turn off the modem, wireless router, and computer;
- 2) Turn on the modem, wait two minutes;
- 3) Turn on the wireless router and wait 1 minute;
- 4) Turn on the computer.

Make sure the Ethernet cables are securely plugged in.

- The Internet status light on the wireless router will be lit if the Ethernet cable to the wireless router from the modem is plugged in securely and the modem and wireless router are turned on.
- For each powered on computer connected to the wireless router with a securely plugged in Ethernet cable, the corresponding wireless router LAN port status light will be lit. The label on the bottom of the wireless router identifies the number of each LAN port.

Make sure the wireless settings in the computer and router match exactly.

The Wireless Network Name (SSID) and WEP settings of the router and wireless computer must match exactly.

Make sure the network settings of the computer are correct.

- LAN and wirelessly connected computers *must* be configured to obtain an IP address automatically via DHCP. Please see [Appendix C, “Preparing Your Network”](#) or the animated tutorials on the CD for help with this.
- Some cable modem ISPs require you to use the MAC address of the computer registered on the account. If so, in the Router MAC Address section of the Basic Settings menu, select “Use this Computer’s MAC Address.” The router will then capture and use the MAC address of the computer that you are now using. You must be using the computer that is registered with the ISP. Click **Apply** to save your settings. Restart the network in the correct sequence.

Check the router status lights to verify correct router operation.

- If the Power light does not turn solid green within 2 minutes after turning the router on, reset the router according to the instructions in [“Restoring the Default Configuration and Password” on page 8-7](#).
- If the Wireless light does not come on, verify that the wireless feature is turned on according to the instructions in [“Understanding Wireless Settings” on page 4-3](#).

Overview of How to Access the Wireless Router

The table below describes how you access the wireless router, depending on the state of the wireless router.

Table 3-1. Ways to access the router

Router State	Access Options	Description
Factory Default Note: The wireless router is supplied in the factory default state. Also, the factory default state is restored when you use the factory reset button. See “Restoring the Default Configuration and Password” on page 8-7 for more information on this feature.	Automatic Access via the Smart Wizard Configuration Assistant	<p>Any time a browser is opened on any computer connected to the wireless router, the wireless router will automatically connect to that browser and display the Configuration Assistant welcome page.</p> <p>There is no need to enter the wireless router URL in the browser, or provide the login user name and password.</p>
	Manually enter a URL to bypass the Smart Wizard Configuration Assistant	<p>You can bypass the Smart Wizard Configuration Assistant feature by typing http://www.routerlogin.net/basicsetting.htm in the browser address bar and clicking Enter. You will not be prompted for a user name or password.</p> <p>This will enable you to manually configure the wireless router even when it is in the factory default state. When manually configuring the router, you must complete the configuration by clicking Apply when finished entering your settings. If you do not do so, a browser on any PC connected to the router will automatically display the router's Configuration Assistant Welcome page rather than the browser's home page.</p>
Configuration Settings Have Been Applied	Enter the standard URL to access the wireless router	<p>Connect to the wireless router by typing either of these URLs in the address field of your browser, then click Enter:</p> <ul style="list-style-type: none"> • http://www.routerlogin.net • http://www.routerlogin.com <p>The wireless router will prompt you to enter the user name of admin and the password. The default password is password.</p>
	Enter the IP address of the wireless router to access the wireless router.	<p>Connect to the wireless router by typing the IP address of the wireless router in the address field of your browser, then click Enter. 192.168.0.1 is the default IP address of the wireless router. The wireless router will prompt you to enter the user name of admin and the password. The default password is password.</p>

How to Log On to the Wireless Router After Configuration Settings Have Been Applied

1. Connect to the wireless router by typing **http://www.routerlogin.net** in the address field of your browser, then click **Enter**.

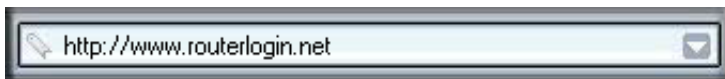

Figure 3-8: Login address

2. For security reasons, the router has its own user name and password. When prompted, enter **admin** for the router user name and **password** for the router password, both in lower case letters. To change the password, see [“Changing the Administrator Password”](#) on page 6-8.

Note: The router user name and password are not the same as any user name or password you may use to log in to your Internet connection.

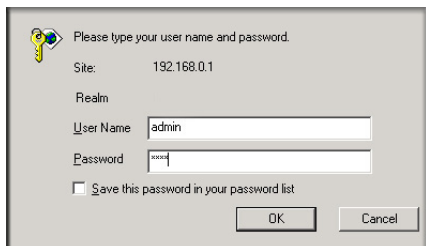

Figure 3-9: Login window

Once you have entered your user name and password, your Web browser should find the WGR614 v6 router and display the home page as shown in below.

Figure 3-10: Login result: WGR614 v6 home page

The browser will then display the WGR614 v6 settings home page.

When the wireless router is connected to the Internet, click the Knowledge Base or the Documentation link under the Web Support menu to view support information or the documentation for the wireless router.

If you do not click Logout, the wireless router will wait 5 minutes after there is no activity before it automatically logs you out.

How to Bypass the Configuration Assistant

1. When the wireless router is in the factory default state, type **http://www.routerlogin.net/basicsetting.htm** in the address field of your browser, then click **Enter**.

When the wireless router is in the factory default state, a user name and password are not required.

2. The browser will then display the WGR614 v6 settings home page shown in “[Login result: WGR614 v6 home page](#)” on page 3-11.

If you do not click Logout, the wireless router will wait 5 minutes after there is no activity before it automatically logs you out.

How to Manually Configure Your Internet Connection

You can manually configure your router using the menu below, or you can allow the Setup Wizard to determine your configuration as described in the previous section.

ISP Does Not Require Login

ISP Does Require Login

Figure 3-11: Browser-based configuration Basic Settings menus

You can manually configure the router using the Basic Settings menu shown in [Figure 3-11](#) using these steps:

1. Connect to the wireless router by typing **http://www.routerlogin.net** in the address field of your browser, then click **Enter**.

2. For security reasons, the wireless router has its own user name and password. When prompted, enter **admin** for the router user name and **password** for the router password, both in lower case letters.
3. Click **Basic Settings** on the Setup menu.
4. If your Internet connection does not require a login, click No at the top of the Basic Settings menu and fill in the settings according to the instructions below. If your Internet connection does require a login, click Yes, and skip to step 5.
 - a. Enter your Account Name (may also be called Host Name) and Domain Name.
These parameters may be necessary to access your ISP's services such as mail or news servers.
 - b. Internet IP Address:
If your ISP has assigned you a permanent, fixed (static) IP address for your computer, select "Use static IP address". Enter the IP address that your ISP assigned. Also enter the netmask and the Gateway IP address. The Gateway is the ISP's router to which your router will connect.
 - c. Domain Name Server (DNS) Address:
If you know that your ISP does not automatically transmit DNS addresses to the router during login, select "Use these DNS servers" and enter the IP address of your ISP's Primary DNS Server. If a Secondary DNS Server address is available, enter it also.

Note: If you enter an address here, restart the computers on your network so that these settings take effect.
 - d. Router's MAC Address:
This section determines the Ethernet MAC address that will be used by the router on the Internet port. Some ISPs will register the Ethernet MAC address of the network interface card in your computer when your account is first opened. They will then only accept traffic from the MAC address of that computer. This feature allows your router to masquerade as that computer by "cloning" its MAC address.

To change the MAC address, select "**Use this Computer's MAC address.**" The router will then capture and use the MAC address of the computer that you are now using. You must be using the one computer that is allowed by the ISP. Or, select "Use this MAC address" and type it in here.
 - e. Click **Apply** to save your settings.
5. If your Internet connection does require a login, fill in the settings according to the instructions below. Select Yes if you normally must launch a login program such as Enternet or WinPOET in order to access the Internet.

Note: After you finish setting up your router, you will no longer need to launch the ISP's login program on your computer in order to access the Internet. When you start an Internet application, your router will automatically log you in.

- a. Select your Internet service provider from the drop-down list.

The screenshot shows a web interface titled "Basic Settings". It contains a section "Does Your Internet Connection Require A Login?" with radio buttons for "Yes" (selected) and "No". Below this is the "Internet Service Provider" section, which includes a dropdown menu currently showing "Telstra Bigpond". A list of options is visible: "Other", "AOL", "Austria (PPTP)", "Telstra Bigpond" (highlighted), and "AOL Cable". To the left of the dropdown are input fields for "Login" and "Password".

Figure 3-12: Basic Settings ISP list

Note: Not all ISPs are listed here. The ones on this list have special requirements.

- b. The screen will change according to the ISP settings requirements of the ISP you select.
- c. Fill in the parameters for your Internet service provider.
- d. Click **Apply** to save your settings. Click the Test button to verify you have Internet access.

Using the Smart Setup Wizard

You can use the Smart Setup Wizard to assist with manual configuration or to verify the Internet connection. The Smart Setup Wizard is not the same as the Smart Wizard configuration assistant (as illustrated in [Figure 3-5](#)) that only appears when the router is in its factory default state. After you configure the wireless router, the Smart Wizard configuration assistant will not appear again.

To use the Smart Setup Wizard to assist with manual configuration or to verify the Internet connection settings, follow this procedure.

1. Connect to the wireless router by typing **http://www.routerlogin.net** in the address field of your browser, then click **Enter**.

2. For security reasons, the router has its own user name and password. When prompted, enter **admin** for the router user name and **password** for the router password, both in lower case letters. To change the password, see “[Changing the Administrator Password](#)” on page 6-8.

Note: The router user name and password are not the same as any user name or password you may use to log in to your Internet connection.

Once you have entered your user name and password, your Web browser should find the WGR614 v6 router and display the home page as shown in “[Login result: WGR614 v6 home page](#)” on page 3-11.

3. Click **Setup Wizard** on the upper left of the main menu.
4. Click **Next** to proceed. Input your ISP settings, as needed.
5. At the end of the Setup Wizard, click the **Test** button to verify your Internet connection. If you have trouble connecting to the Internet, use the Troubleshooting Tips “[Troubleshooting Tips](#)” on page 3-8 to correct basic problems, or refer to [Chapter 8, “Troubleshooting.”](#)

NETGEAR Product Registration, Support, and Documentation

Register your product at <http://www.NETGEAR.com/register>. Registration is required before you can use our telephone support service.

Product updates and Web support are always available by going to:
<http://kbserver.netgear.com/products/WGR614v6.asp>.

Documentation is available on the CD and at
<http://kbserver.netgear.com/documentation/WGR614v6.asp>.

When the wireless router is connected to the Internet, click the Knowledge Base or the Documentation link under the Web Support menu to view support information or the documentation for the wireless router.

Chapter 4

Wireless Configuration

This chapter describes how to configure the wireless features of your WGR614 v6 router. In planning your wireless network, you should consider the level of security required. You should also select the physical placement of your firewall in order to maximize the network speed. For further information on wireless networking, refer to [Appendix D, “Wireless Networking Basics.”](#)

Observe Performance, Placement, and Range Guidelines

The operating distance or range of your wireless connection can vary significantly based on the physical placement of the wireless firewall. The latency, data throughput performance, and notebook power consumption of wireless adapters also vary depending on your configuration choices.



Note: Failure to follow these guidelines can result in significant performance degradation or inability to wirelessly connect to the router. For complete range/performance specifications, please see [Appendix A, “Technical Specifications.”](#)

For best results, place your firewall:

- Near the center of the area in which your computers will operate.
- In an elevated location such as a high shelf where the wirelessly connected computers have line-of-sight access (even if through walls).
- Away from sources of interference, such as computers, microwaves, and 2.4 GHz cordless phones.
- Away from large metal surfaces.

The time it takes to establish a wireless connection can vary depending on both your security settings and placement. WEP connections can take slightly longer to establish. Also, WEP encryption can consume more battery power on a notebook computer.

Implement Appropriate Wireless Security



Note: Indoors, computers can connect over 802.11b/g wireless networks at ranges of up to 300 feet. Such distances can allow for others outside of your immediate area to access your network.

Unlike wired network data, your wireless data transmissions can be received well beyond your walls by anyone with a compatible adapter. For this reason, use the security features of your wireless equipment. The WGR614 v6 router provides highly effective security features which are covered in detail in this chapter. Deploy the security features appropriate to your needs.

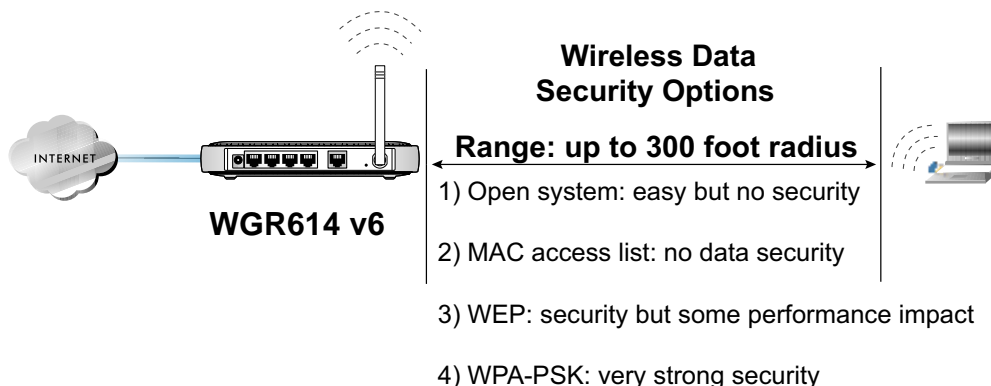

Figure 4-1: WGR614 v6 wireless data security options

There are several ways you can enhance the security of your wireless network.

- **Restrict Access Based on MAC address.** You can restrict access to only trusted computers so that unknown computers cannot wirelessly connect to the WGR614 v6. MAC address filtering adds an obstacle against unwanted access to your network, but the data broadcast over the wireless link is fully exposed.
- **Turn Off the Broadcast of the Wireless Network Name SSID.** If you disable broadcast of the SSID, only devices that have the correct SSID can connect. This nullifies the wireless network 'discovery' feature of some products such as Windows XP, but the data is still fully exposed to a determined snoop using specialized test equipment like wireless sniffers.
- **WEP.** Wired Equivalent Privacy (WEP) data encryption provides data security. WEP Shared Key authentication and WEP data encryption will block all but the most determined eavesdropper.

- **WPA-PSK.** Wi-Fi Protected Access (WPA) data encryption provides strong data security. WPA-PSK will block eavesdropping. Because this is a new standard, wireless device driver and software availability may be limited.
- **Turn Off the Wired LAN.** If you disable the wireless LAN, wireless devices cannot communicate with the router at all. You might choose to turn off the wireless the LAN when you are away and the others in the household all use wired connections.

Understanding Wireless Settings

To configure the Wireless settings of your firewall, click the Wireless link in the main menu of the browser interface. The Wireless Settings menu will appear, as shown below.

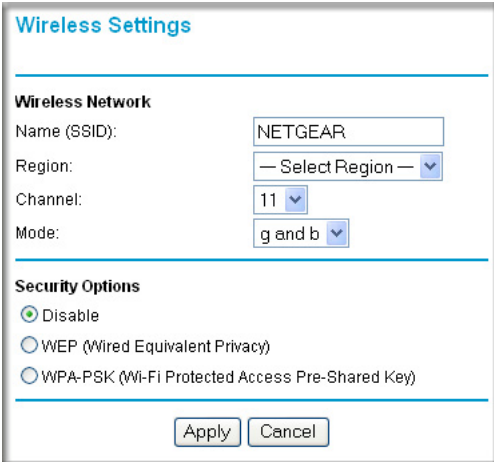

The screenshot shows a web browser window titled "Wireless Settings". The page is divided into two main sections: "Wireless Network" and "Security Options".

Wireless Network

- Name (SSID): A text input field containing "NETGEAR".
- Region: A dropdown menu with the text "-- Select Region --".
- Channel: A dropdown menu with the value "11".
- Mode: A dropdown menu with the value "g and b".

Security Options

- Disable
- WEP (Wired Equivalent Privacy)
- WPA-PSK (Wi-Fi Protected Access Pre-Shared Key)

At the bottom of the form are two buttons: "Apply" and "Cancel".

Figure 4-2: Wireless Settings menu

- **Name (SSID).** The SSID is also known as the wireless network name. Enter a value of up to 32 alphanumeric characters. In a setting where there is more than one wireless network, different wireless network names provide a means for separating the traffic. Any device you want to participate in a particular wireless network will need to use this SSID for that network. The WGR614 v6 default SSID is: **NETGEAR**.
- **Region.** This field identifies the region where the WGR614 v6 can be used. It may not be legal to operate the wireless features of the wireless router in a region other than one of those identified in this field.

- **Channel.** This field determines which operating frequency will be used. It should not be necessary to change the wireless channel unless you notice interference problems with another nearby access point. For more information on the wireless channel frequencies please refer to [“Wireless Channels” on page D-2.](#)
- **Mode.** This field determines which data communications protocol will be used. You can select “g only,” “b only,” or “g and b.” “g only” dedicates the WGR614 v6 to communicating with the higher bandwidth 802.11g wireless devices exclusively. “b only” dedicates the WGR614 v6 to communicating with the higher bandwidth 802.11b wireless devices exclusively. The “g and b” mode provides backward compatibility with the slower 802.11b wireless devices while still enabling 802.11g communications.
- **Security Options.** These options are the wireless security features you can enable. The table below identifies the various basic wireless security options. A full explanation of these standards is available in [Appendix D, “Wireless Networking Basics.”](#)

Table 4-1. Basic Wireless Security Options

Field	Description
Automatic	No wireless security.
WEP	<p>WEP offers the following options:</p> <ul style="list-style-type: none"> • Open System With Open Network Authentication and 64- or 128-bit WEP Data Encryption, the WGR614 v6 <i>does</i> perform 64- or 128-bit data encryption but <i>does not</i> perform any authentication. • Shared Key Shared Key authentication encrypts the SSID and data. Choose the Encryption Strength (64- or 128-bit data encryption). Manually enter the key values or enter a word or group of printable characters in the Passphrase box. Manually entered keys <i>are</i> case sensitive but passphrase characters <i>are not</i> case sensitive. Note: Not all wireless adapter configuration utilities support passphrase key generation. • Auto
WPA-PSK	<p>WPA-Pre-shared Key <i>does</i> perform authentication, uses 128-bit data encryption and dynamically changes the encryption keys making it nearly impossible to circumvent. Enter a word or group of printable characters in the Password Phrase box. These characters <i>are</i> case sensitive.</p> <p>Note: Not all wireless adapter configuration utilities support WPA. Furthermore, client software is required on the client. Windows XP and Windows 2000 with Service Pack 3 do include the client software that supports WPA. Nevertheless, the wireless adapter hardware and driver must also support WPA.</p>

To configure the advanced wireless settings of your firewall, click the Wireless Setup link in the Advanced section of the main menu of the browser interface. The Wireless Settings menu will appear, as shown below.

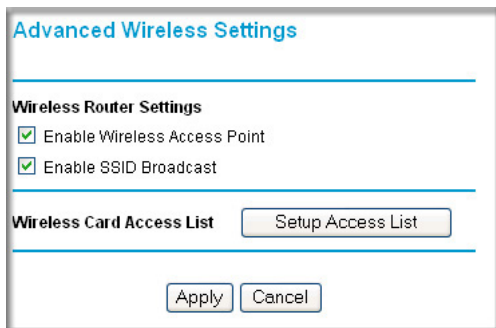

Figure 4-3: Advanced Wireless Settings menu

- **Allow Broadcast of Name (SSID).** If you disable broadcast of the SSID, only devices that have the correct SSID can connect. Disabling SSID broadcast nullifies the wireless network 'discovery' feature of some products such as Windows XP.
- **Enable Wireless Access Point.** If you disable the wireless access point, wireless devices cannot connect to the WGR614 v6.
- **Wireless Card Access List.** When the Trusted PCs Only radio button is selected, the WGR614 v6 checks the MAC address of the wireless station and only allows connections to computers identified on the trusted computers list.

Information to Gather Before Changing Basic Wireless Settings

Before customizing your wireless settings, print this form and record the following information. If you are working with an existing wireless network, the person who set up or is responsible for the network will be able to provide this information. Otherwise, you will choose the settings for your wireless network. Either way, record the settings for your wireless network in the spaces below.

- **Wireless Network Name (SSID):** _____ The SSID, identifies the wireless network. You can use up to 32 alphanumeric characters. The SSID *is* case sensitive. The SSID in the wireless adapter card must match the SSID of the wireless router. In some configuration utilities (such as in Windows XP), the term “wireless network name” is used instead of SSID.

- **If WEP Authentication is Used.** Circle one: **Open System, Shared Key, or Auto.**

Note: If you select Shared Key, the other devices in the network will not connect unless they are set to Shared Key as well and are configured with the correct key.

- **WEP Encryption key size.** Choose one: **64-bit** or **128-bit**. Again, the encryption key size must be the same for the wireless adapters and the wireless router.

- **Data Encryption (WEP) Keys.** There are two methods for creating WEP data encryption keys. Whichever method you use, record the key values in the spaces below.

- **Passphrase method.** _____ These characters *are* case sensitive. Enter a word or group of printable characters and click the Generate Keys button. Not all wireless devices support the passphrase method.

- **Manual method.** These values *are not* case sensitive. For 64-bit WEP, enter 10 hex digits (any combination of 0-9 or a-f). For 128-bit WEP, enter 26 hex digits.

Key 1: _____

Key 2: _____

Key 3: _____

Key 4: _____

- **If WPA-PSK Authentication is Used.**

- **Passphrase:** _____ These characters *are* case sensitive. Enter a word or group of printable characters. When you use WPA-PSK, the other devices in the network will not connect unless they are set to WPA-PSK as well and are configured with the correct Passphrase.

Use the procedures described in the following sections to configure the WGR614 v6. Store this information in a safe place.

Default Factory Settings

When you first receive your WGR614 v6, the default factory settings are shown below. You can restore these defaults with the Factory Default Restore button on the rear panel. After you install the WGR614 v6 router, use the procedures below to customize any of the settings to better meet your networking needs.

FEATURE	DEFAULT FACTORY SETTINGS
Wireless Access Point	Enabled
Wireless Access List (MAC Filtering)	All wireless stations allowed
SSID broadcast	Enabled
SSID	NETGEAR
11b/g RF Channel	11
Mode	g and b
Authentication Type	Open System
WEP	Disabled

How to Set Up and Test Basic Wireless Connectivity



Note: If you use a wireless computer to configure WPA settings, you will be disconnected when you click Apply. Reconfigure your wireless adapter to match the new settings or access the wireless router from a wired computer to make any further changes.

Follow the instructions below to set up and test basic wireless connectivity. Once you have established basic wireless connectivity, you can enable security settings appropriate to your needs.

1. Log in to the WGR614 v6 firewall at its default LAN address of <http://www.routerlogin.net> with its default user name of **admin** and default password of **password**, or using whatever LAN address and password you have set up.

2. Click **Wireless Settings** in the main menu of the WGR614 v6 firewall.

The screenshot shows the 'Wireless Settings' configuration page. Under the 'Wireless Network' section, the SSID is 'NETGEAR', the region is 'Select Region', the channel is '11', and the mode is 'g and b'. Under 'Security Options', 'Disable' is selected. 'Apply' and 'Cancel' buttons are at the bottom.

Figure 4-4: Wireless Settings menu

3. Choose a suitable descriptive name for the wireless network name (SSID). In the SSID box, enter a value of up to 32 alphanumeric characters. The default SSID is NETGEAR.

Note: The SSID is case sensitive; NETGEAR is not the same as nETgear. Also, the SSID of any wireless access adapters must match the SSID you configure in the 54 Mbps Wireless Router WGR614 v6. If they do not match, you will not get a wireless connection to the WGR614 v6.

4. Set the Region. Select the region in which the wireless interface will operate.
5. Set the Channel. The default channel is 11.

This field determines which operating frequency will be used. It should not be necessary to change the wireless channel unless you notice interference problems with another nearby wireless router or access point. Select a channel that is not being used by any other wireless networks within several hundred feet of your firewall. For more information on the wireless channel frequencies please refer to [“Wireless Channels” on page D-2](#).

6. For initial configuration and test, leave the Wireless Card Access List set to “Everyone” and the Encryption Strength set to “Disabled.”
7. Click **Apply** to save your changes.



Note: If you are configuring the firewall from a wireless computer and you change the firewall's SSID, channel, or security settings, you will lose your wireless connection when you click on Apply. You must then change the wireless settings of your computer to match the firewall's new settings.

8. Configure and test your computers for wireless connectivity.

Program the wireless adapter of your computers to have the same SSID and channel that you configured in the router. Check that they have a wireless link and are able to obtain an IP address by DHCP from the firewall.

Warning: The Network Name (SSID) is case sensitive. If NETGEAR is the Network Name (SSID) in your wireless router, you must enter NETGEAR in your computer's wireless settings. Typing nETgear will not work.

Once your computers have basic wireless connectivity to the firewall, you can configure the advanced wireless security functions of the firewall.

How to Configure WEP

To configure WEP data encryption, follow these steps:



Note: If you use a wireless computer configure WEP settings, you will be disconnected when you click on Apply. You must then either configure your wireless adapter to match the wireless router WEP settings or access the wireless router from a wired computer to make any further changes.

1. Log in to the WGR614 v6 firewall at its default LAN address of <http://www.routerlogin.net> with its default user name of **admin** and default password of **password**, or using whatever LAN address and password you have set up.
2. Click **Wireless Settings** in the main menu of the WGR614 v6 firewall.
3. From the Security Options menu, select **WEP**. The WEP options display.

4. Select the Authentication Type and Encryptions strength from the drop-down lists.

Wireless Settings

Wireless Network

Name (SSID):

Region:

Channel:

Mode:

Security Options

Disable

WEP (Wired Equivalent Privacy)

WPA-PSK (Wi-Fi Protected Access Pre-Shared Key)

Security Encryption (WEP)

Authentication Type:

Encryption Strength:

Security Encryption (WEP) Key

Passphrase:

Key 1:

Key 2:

Key 3:

Key 4:

Figure 4-5. Wireless Settings encryption menu

5. You can manually or automatically program the four data encryption keys. These values must be identical on all computers and Access Points in your network.
 - Automatic - Enter a word or group of printable characters in the Passphrase box and click the Generate button. The passphrase is case sensitive; NETGEAR is not the same as nETgear. The four key boxes will be automatically populated with key values.
 - Manual - Enter ten hexadecimal digits (any combination of 0-9, a-f, or A-F). These entries are not case sensitive; AA is the same as aa. Select which of the four keys will be active.

Please refer to [“WEP Wireless Security” on page D-4](#) for a full explanation of each of these options, as defined by the IEEE 802.11 wireless communication standard.

6. Click **Apply** to save your settings.